



**ROAD TRAFFIC REGULATION ACT 1984 – SECTIONS 64 AND 65  
AUTHORISATION OF TRAFFIC SIGNS AND SPECIAL DIRECTIONS**

The Secretary of State for Transport in exercise of powers under Sections 64 and 65 of the Road Traffic Regulation Act 1984, and of all other powers enabling him in that behalf, hereby gives the authorisation contained in paragraphs 2 and 3 of this Instrument and the directions contained in paragraph 4 of this Instrument.

1. In this Instrument –

“Authorised sign” means a traffic sign whose placing on roads is authorised by paragraph 2;

“the Clean Air Zone” means the area in respect of which charges are imposed for the keeping or use of motor vehicles not meeting certain emission standards pursuant to a Scheme;

“Scheme” means a scheme for imposing charges made in respect of keeping or use of certain motor vehicles not meeting certain emission standards made by Newcastle City Council pursuant to Part III of the Transport Act 2000;

“the 2016 Regulations” means the Traffic Signs Regulations and General Directions 2016 (Part 1 of S.I. 2016/362).

2. The Secretary of State hereby:-

(1) authorises the erection at appropriate sites on or near any road for which Newcastle City Council is the traffic authority of a traffic sign (hereinafter referred to as “the authorised sign NP 677.1”) conforming as to size, colour and character with that referenced NP 677.1 in the attached set of drawings save that (i) the reference to the times of operation may be varied or omitted; (ii) the x-height may be varied as



indicated; and (iii) the name and logo of the traffic authority in the upper panel may be varied as appropriate; and

- (2) authorises the erection at the said sites of a traffic sign (hereinafter referred to as “the authorised sign NP 818.8”) conforming as to size, colour and character with that referenced NP 818.8 in the said set of drawings save that (i) the reference to the times of operation may be varied or omitted; (ii) the x-height may be varied as indicated; (iii) the distance may be varied; (iv) “ahead” may be placed centrally below the distance; and (v) “ahead” may be omitted and an arrow pointing horizontally to the left or to the right placed centrally below the distance; and
- (3) authorises the erection at the said sites of a traffic sign (hereinafter referred to as “the authorised sign NP 894.1”) conforming as to size, colour and character with that referenced NP 894.1 in the said set of drawings save that (i) the Clean Air Zone symbol may be placed to the left of the camera symbol; and (ii) a legend may be added giving the name, and any logo, of the enforcement authority; and
- (4) authorises the erection at the said sites of a traffic sign (hereinafter referred to as “the authorised sign NP 664.4”) conforming as to size, colour and character with that referenced NP 664.4 in the said set of drawings; and
- (5) authorises the erection at the said sites of a traffic sign (hereinafter referred to as “the authorised sign E”) conforming as to colour and character with that referenced “Sign E” in the said set of drawings save that (i) the reference to the times of operation may be varied or omitted; (ii) the reference to the date may be varied or omitted; (iii) the reference in the top panel to the city may be omitted or varied to the name of a council, city or county; (iv) the legend “BOUNDARY” in the top panel may be omitted; (v) panels may be omitted or added; (vi) panel dividers may be omitted; (vii) a distance with or without an arrow pointing to the left or to the right may be added; (viii) an arrow pointing to the left or to the right may be added; and
- (6) directs that the Clean Air Zone symbol shown in the said set of drawings (hereinafter referred to as “the authorised symbol S 68”) conforming as to size, colour and



character with that referenced S 68 in the said set of drawings may be placed on any appropriate sign in Schedule 12, Part 2, Items 1, 2 and 3 of the 2016 Regulations;  
and

(7) authorises the display of the authorised sign NP 677.1, the authorised sign NP 818.8, the authorised sign NP 894.1, the authorised sign NP 664.4, the authorised sign E and signs incorporating the authorised symbol S 68 on variable message signs as defined in Schedule 1 of the 2016 Regulations.

3.

- (1) The provisions of Regulations 5, 7, 8 and 11 of the 2016 Regulations shall apply to the authorised sign NP 677.1 as they do to the sign shown in Item 1 of the sign table in Schedule 8, Part 4 (diagram 677) to those Regulations.
- (2) The provisions of Regulations 5, 7, 8 and 11 of the 2016 Regulations shall apply to the authorised sign NP 818.8 as they do to the sign shown in Item 3 of the sign table in Schedule 8, Part 4 (diagram 818.6) to those Regulations.
- (3) The provisions of Regulations 5, 7, 8 and 11 of the 2016 Regulations shall apply to the authorised sign NP 894.1 as they do to the sign shown in Item 5 of the sign table in Schedule 8, Part 4 (diagram 894) to those Regulations.
- (4) The provisions of Regulations 5, 7, 8 and 11 of the 2016 Regulations shall apply to the authorised sign NP 664.4 as they do to the sign shown in Item 1 of the sign table in Schedule 7, Part 2 (diagram 664) to those Regulations.
- (5) The provisions of Regulations 5, 7, 8 and 11 of the 2016 Regulations shall apply to the authorised symbol S 68 as they do to the symbol shown in Item 19 of the sign table in Schedule 12, Part 11 to those Regulations.



(6) The provisions of Regulations 5, 7, 8 and 11 of the 2016 Regulations shall apply to the authorised sign E as they do to the sign shown in Item 37 of the sign table in Schedule 13, Part 6 (diagram 7014) to those Regulations.

4. The Secretary of State hereby directs that –

- (1) Without prejudice to any regulations made under paragraph 22 (1) (e) of Schedule 9 to the Road Traffic Regulation Act 1984; the authorised sign NP 677.1 shall be placed on or near any road in Newcastle in sufficient numbers and in appropriate positions to indicate to all traffic the entrance to the Clean Air Zone and the nature of the provisions of a Scheme.
- (2) Without prejudice to any regulations made under paragraph 22 (1) (e) of Schedule 9 to the Road Traffic Regulation Act 1984; the authorised sign NP 818.8 or signs incorporating the authorised symbol S 68 may be placed on or near any road in Newcastle in sufficient numbers and in appropriate positions to provide advance indication to all traffic of the Clean Air Zone and the nature of the provisions of a Scheme.
- (3) Without prejudice to any regulations made under paragraph 22 (1) (e) of Schedule 9 to the Road Traffic Regulation Act 1984; the authorised sign NP 894.1 may be placed on or near any road in Newcastle in sufficient numbers and in appropriate positions as a reminder to all traffic within the Clean Air Zone in which cameras are used to enforce traffic regulations.
- (4) Without prejudice to any regulations made under paragraph 22 (1) (e) of Schedule 9 to the Road Traffic Regulation Act 1984; the authorised sign NP 664.4 shall be placed on or near any road in Newcastle in sufficient numbers and in appropriate positions to indicate to all traffic the end of the Clean Air Zone.



(5) Without prejudice to any regulations made under paragraph 22 (1) (e) of Schedule 9 to the Road Traffic Regulation Act 1984; the authorised sign E shall be placed on or near any road in Newcastle in sufficient numbers and in appropriate positions to indicate to all traffic information pertaining to the introduction of the Clean Air Zone and the nature of the provisions of a Scheme.

(6) The authorised sign NP 677.1, the authorised sign NP 818.8, the authorised sign NP 894.1, the authorised sign NP 664.4, the authorised sign E and the authorised symbol S 68 when incorporated on signs, may be placed only as appropriate to indicate the provisions of a Scheme.

(7) Without prejudice to any statutory provision to the like effect, it is a condition of this authorisation that the placing of the authorised sign NP 677.1, the authorised sign NP 818.8, the authorised sign NP 894.1, the authorised sign NP 664.4, the authorised sign E and signs incorporating the authorised symbol S 68 on or near the said roads shall continue to have effect only until such day as may be appointed by one month's notice given by the Secretary of State in writing to the traffic authority for the removal or alteration of the authorised signs, and on that day the said authorisation shall, without prejudice to the giving of any further authorisation or direction, cease to have effect.

Dated *6th September* ..... 2019

Signed by authority of the Secretary of State



.....  
A Delegated Official of the Department for Transport

Before using this drawing, confirm that it has not been superseded.

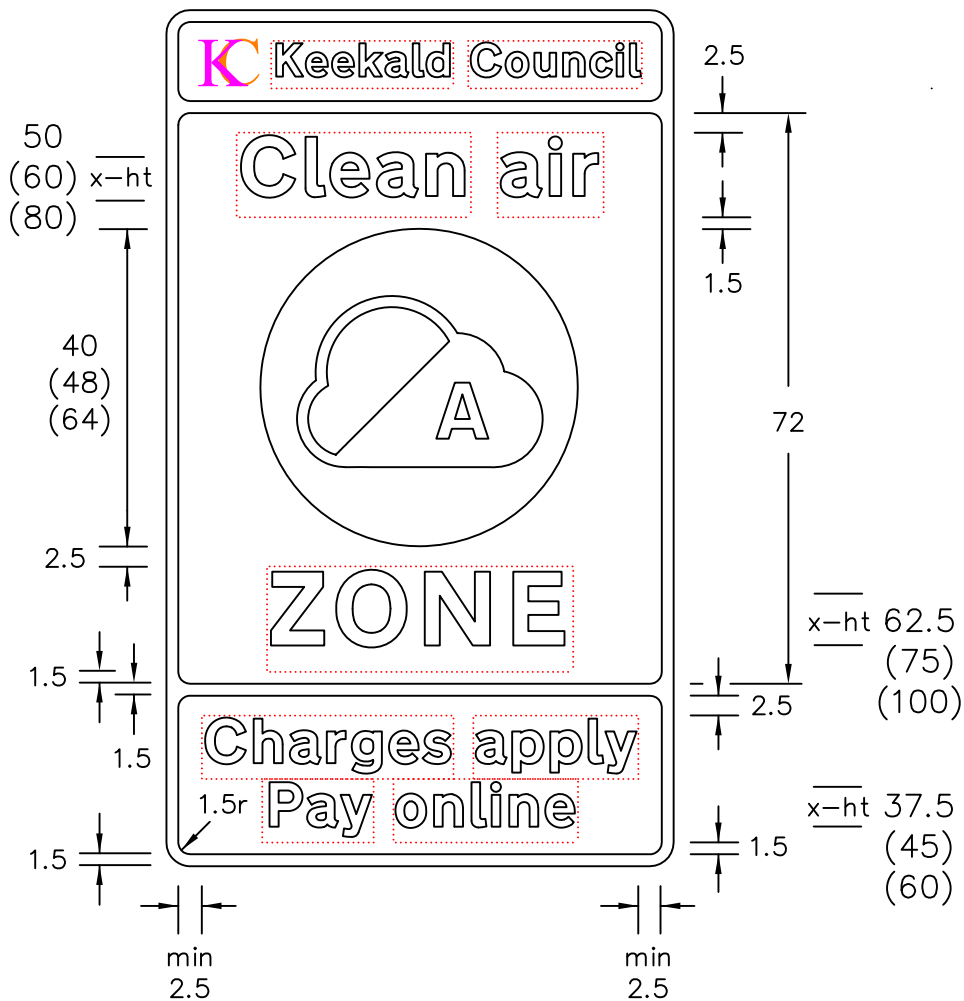

NOTES:

1. The legends are from the Transport Heavy alphabet at the x-heights shown.
2. Details of the Clean Air Zone (CAZ) symbol are given on drawing S 68.
3. The tile outlines do not form part of the sign.
4. COLOURS
  - Background ----- WHITE
  - Legends & Border ---- BLACK
  - CAZ Symbol ----- GREEN/WHITE
5. DIMENSIONS
  - X-heights are in millimeters, other dimensions are in stroke widths (4sw = x-height).

Alternative bottom panel with times

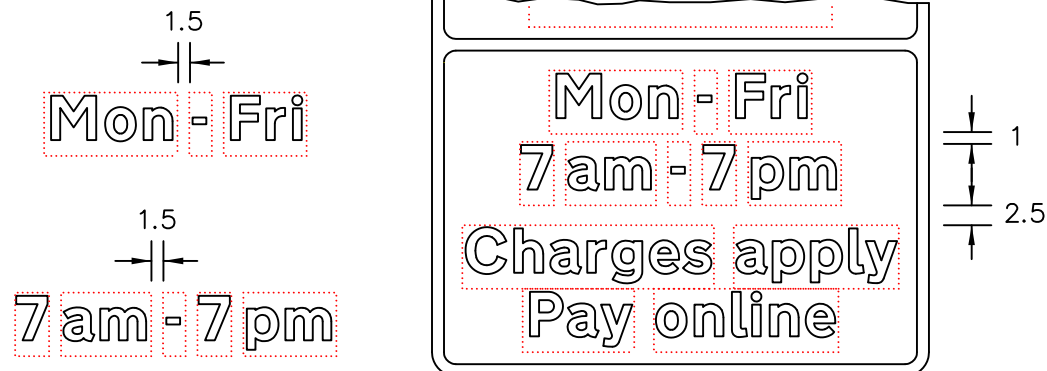

NP677x1

© CROWN COPYRIGHT

 Department for Transport	Title: Regulatory Signs	Issue: Date:	Drawn by :	Related drawings :	Drawing No.
	ENTRANCE TO CLEAN AIR ZONE	A: 31.8.18	A.K.	S 68	NP 677.1
		B:	Approved by:		
		C:	J.B.		

**KC** Keekald Council

**Clean air**



**ZONE**

**Charges apply  
Pay online**

**KC** Keekald Council

**Clean air**



**ZONE**

**Mon - Fri  
7 am - 7 pm  
Charges apply  
Pay online**

NOTES:

1. The legends are from the Transport Medium alphabet at the x-heights shown.
2. Details of the Clean Air Zone (CAZ) symbol are given on drawing S 68.
3. The tile outlines do not form part of the sign.
4. COLOURS  
 Background -----BLUE  
 Legend & Border -----WHITE  
 Thin border to CAZ Symbol ---- WHITE  
 CAZ Symbol ----- GREEN/WHITE
5. DIMENSIONS  
 X-heights are in millimeters, other dimensions are in stroke widths (4sw = x-height).
6. See sheet 2 for a variant showing times of operation.

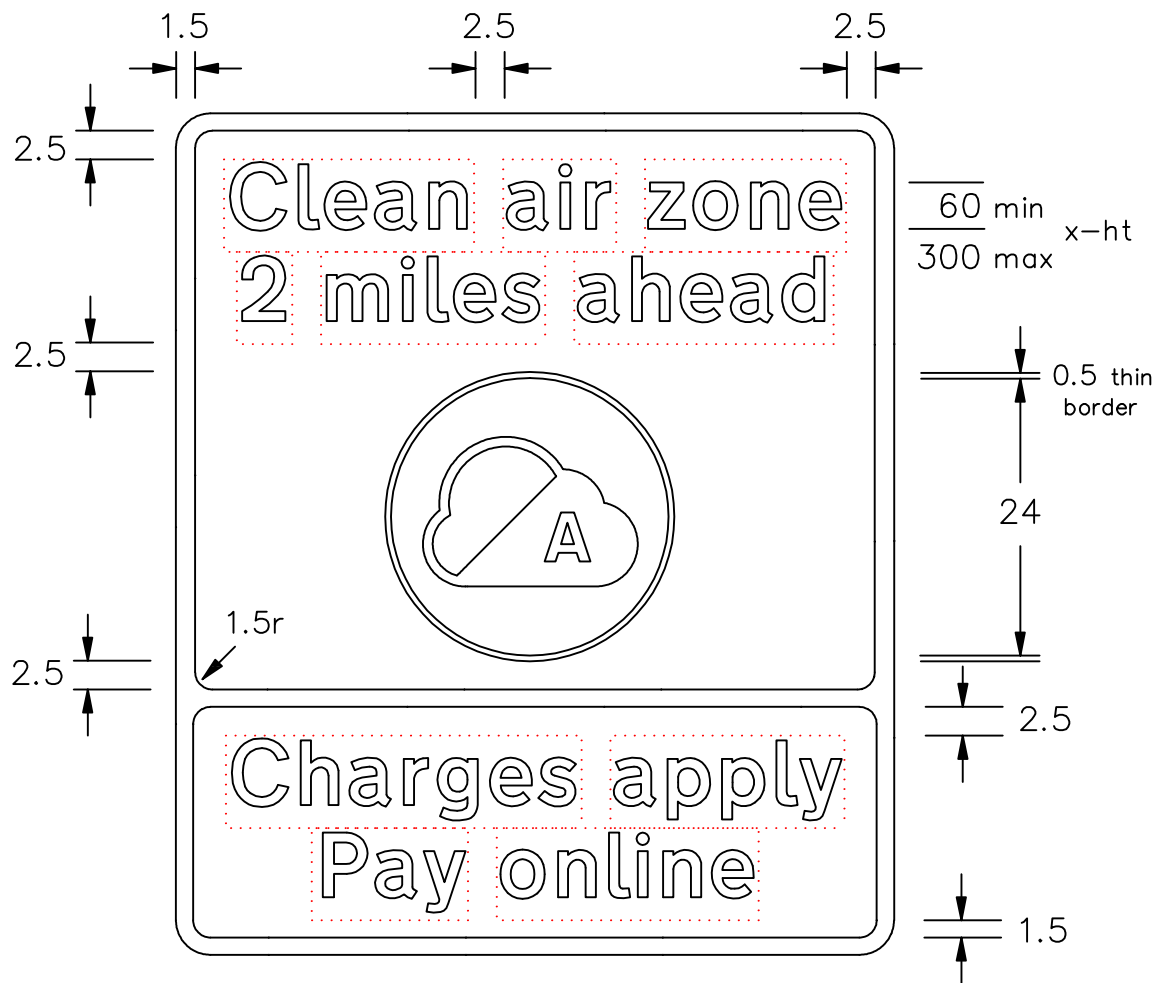

Before using this drawing, confirm that it has not been superseded.

© CROWN COPYRIGHT

NP818x8



Title: Informatory Sign  
 ADVANCE WARNING OF ENTRY  
 INTO A CLEAN AIR ZONE AREA

Issue: Date:  
 A: 31.8.18  
 B:  
 C:

Drawn by :  
 A.K.  
 Approved by:  
 J.B.

Related drawings :  
 S 68

Drawing No.  
 NP 818.8  
 Sheet 1 of 2



x-ht  
 60 min  
 300 max

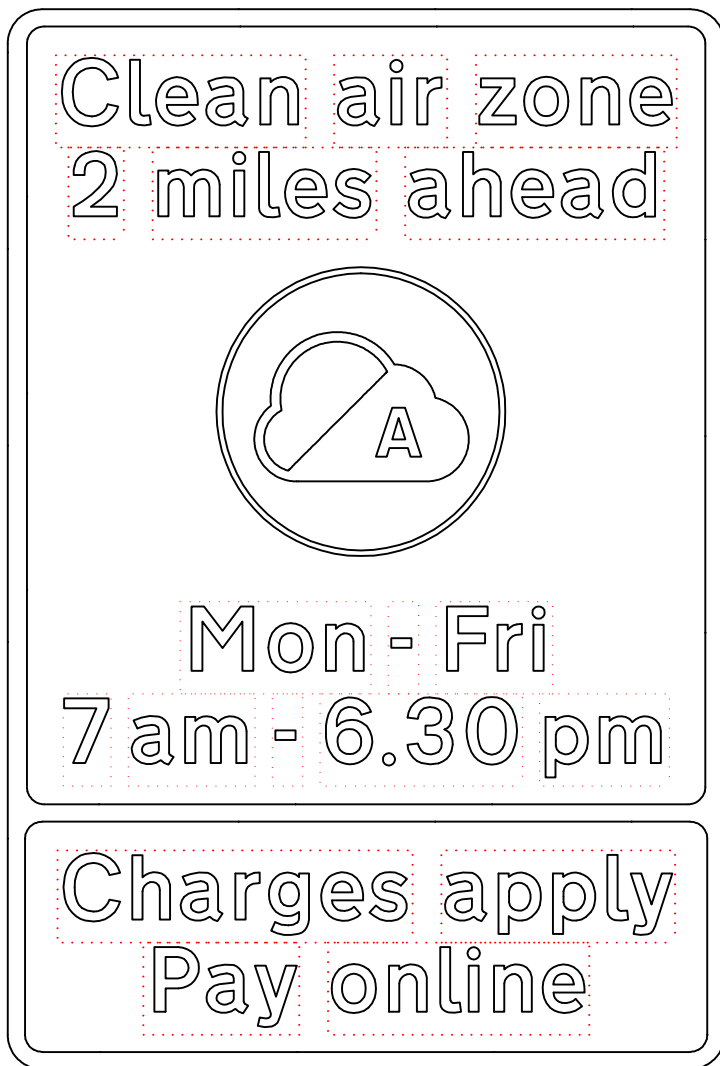

NOTES:

1. The legends are from the Transport Medium alphabet at the x-heights shown.
2. Details of the Clean Air Zone (CAZ) symbol are given on drawing S 68.
3. The tile outlines do not form part of the sign.
4. COLOURS  
 Background ----- BLUE  
 Legend & Border ----- WHITE  
 Thin border to CAZ Symbol ----- WHITE  
 CAZ Symbol ----- GREEN/WHITE
5. DIMENSIONS  
 X-heights are in millimeters, other dimensions are in stroke widths (4sw = x-height).

Before using this drawing, confirm that it has not been superseded.

© CROWN COPYRIGHT

NP818x8

 Department for Transport	Title: Informatory Sign ADVANCE WARNING OF ENTRY INTO A CLEAN AIR ZONE AREA	Issue: Date: A: 31.8.18 B: C:	Drawn by : A.K. Approved by: J.B.	Related drawings : S 68	Drawing No. NP 818.8 Sheet 2 of 2
---	---	--	--	----------------------------	---

**Clean air zone  
2 miles ahead**



**Charges apply  
Pay online**

**Clean air zone  
2 miles ahead**



**Mon - Fri  
7 am - 6.30 pm**

**Charges apply  
Pay online**

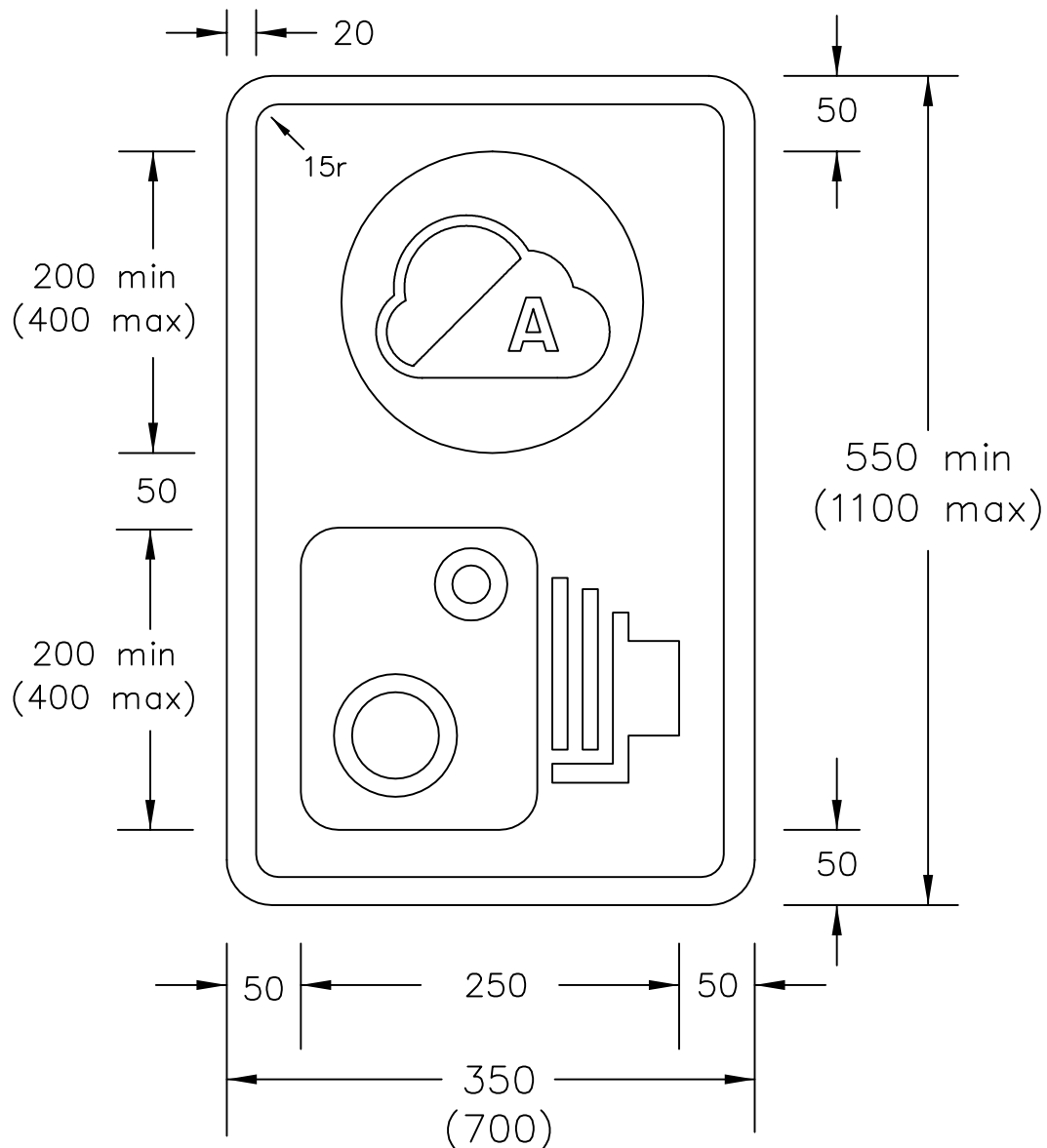

NOTES:

1. Details of the camera symbol are given on drawing S 58.
2. Details of the Clean Air Zone (CAZ) symbol are given on drawing S 68.
3. Dimensions are in millimeters.
4. COLOURS:
 

Background -----	WHITE
Border -----	BLACK
CAZ Symbol -----	GREEN/WHITE
Camera Symbol -----	BLACK

Before using this drawing, confirm that it has not been superseded.

© CROWN COPYRIGHT

NP894x1

 <b>Department for Transport</b>	Title:                    Informatory Sign <div style="text-align: center; font-weight: bold; font-size: 1.2em;">CAMERA AHEAD AND REMINDER OF CLEAN AIR ZONE</div>	Issue:    Date: A:        31.8.18 B:        14.8.19 C:	Drawn by : A.K. Approved by: J.B.	Related drawings : <div style="font-size: 1.2em; font-weight: bold;">S 58, S 68</div>	Drawing No. <div style="font-size: 2em; font-weight: bold; text-align: center;">NP 894.1</div>
---	---	---	--	--	---



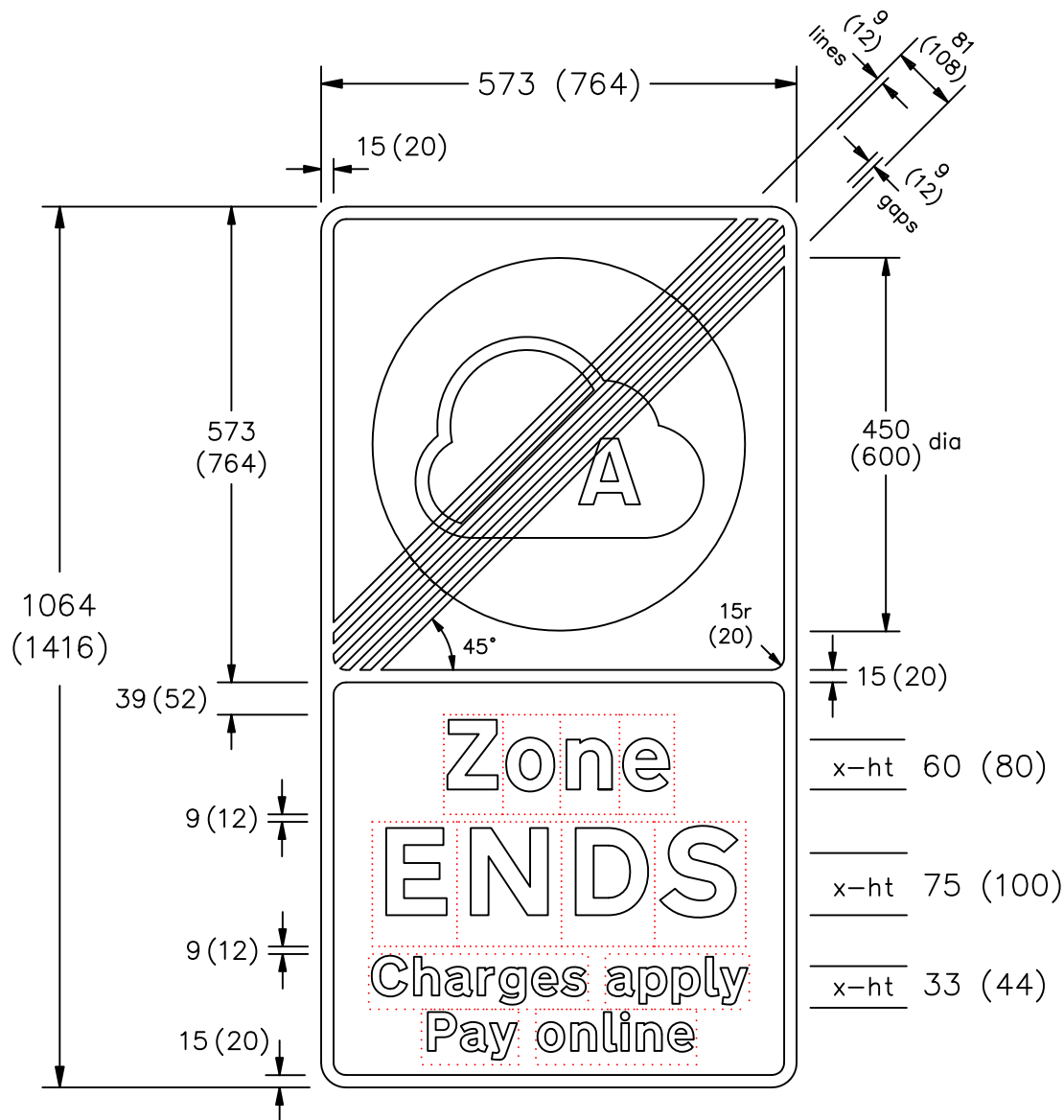

NOTES:

1. The legends are from the Transport Heavy alphabet at the x-heights shown.
2. Details of the Clean Air Zone (CAZ) symbol are given on drawing S 68.
3. The tile outlines do not form part of the sign.
4. COLOURS  
 Backgrounds ----- WHITE  
 Legends, Borders & Diagonal bars ----- BLACK  
 CAZ Symbol ----- GREEN/WHITE
5. DIMENSIONS  
 All dimensions are in millimeters.

Before using this drawing, confirm that it has not been superseded.

© CROWN COPYRIGHT

NP664x4



Title: Regulatory Sign  
 END OF CLEAN AIR ZONE

Issue: Date:  
 A: 31.8.18  
 B:  
 C:

Drawn by :  
 A.K.  
 Approved by:  
 J.B.

Related drawings :  
 S 68

Drawing No.  
 NP 664.4



**Zone**  
**ENDS**

**Charges apply**  
**Pay online**

Before using this drawing, confirm that it has not been superseded.

NOTES:

1. The tile outline does not form part of the sign.
2. Dimensions are given in millimeters.
3. The symbol is not reversible.
4. COLOURS:  
 Background ----- GREEN  
 CAZ Symbol ----- WHITE  
 Legend ----- GREEN

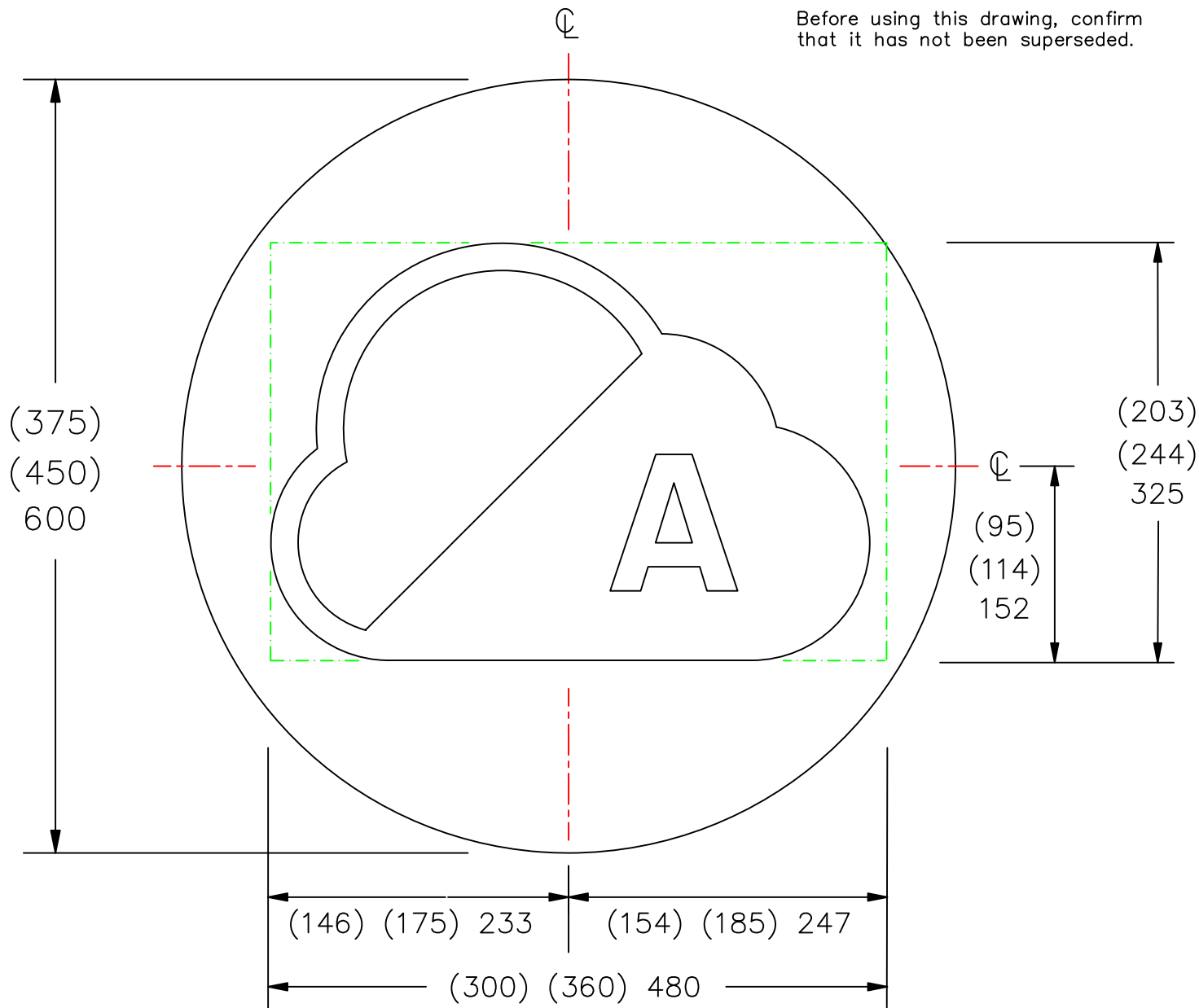

S68

© CROWN COPYRIGHT

 Department for Transport	Title: Symbol <b>CLEAN AIR ZONE</b>	Issue: A: Date: 31.8.18 B: C:	Drawn by: A.K. Approved by: J.B.	Related drawings :	Drawing No. S 68 sheet 1 of 5
--	--	--	-------------------------------------	--------------------	-------------------------------

Before using this drawing, confirm that it has not been superseded.

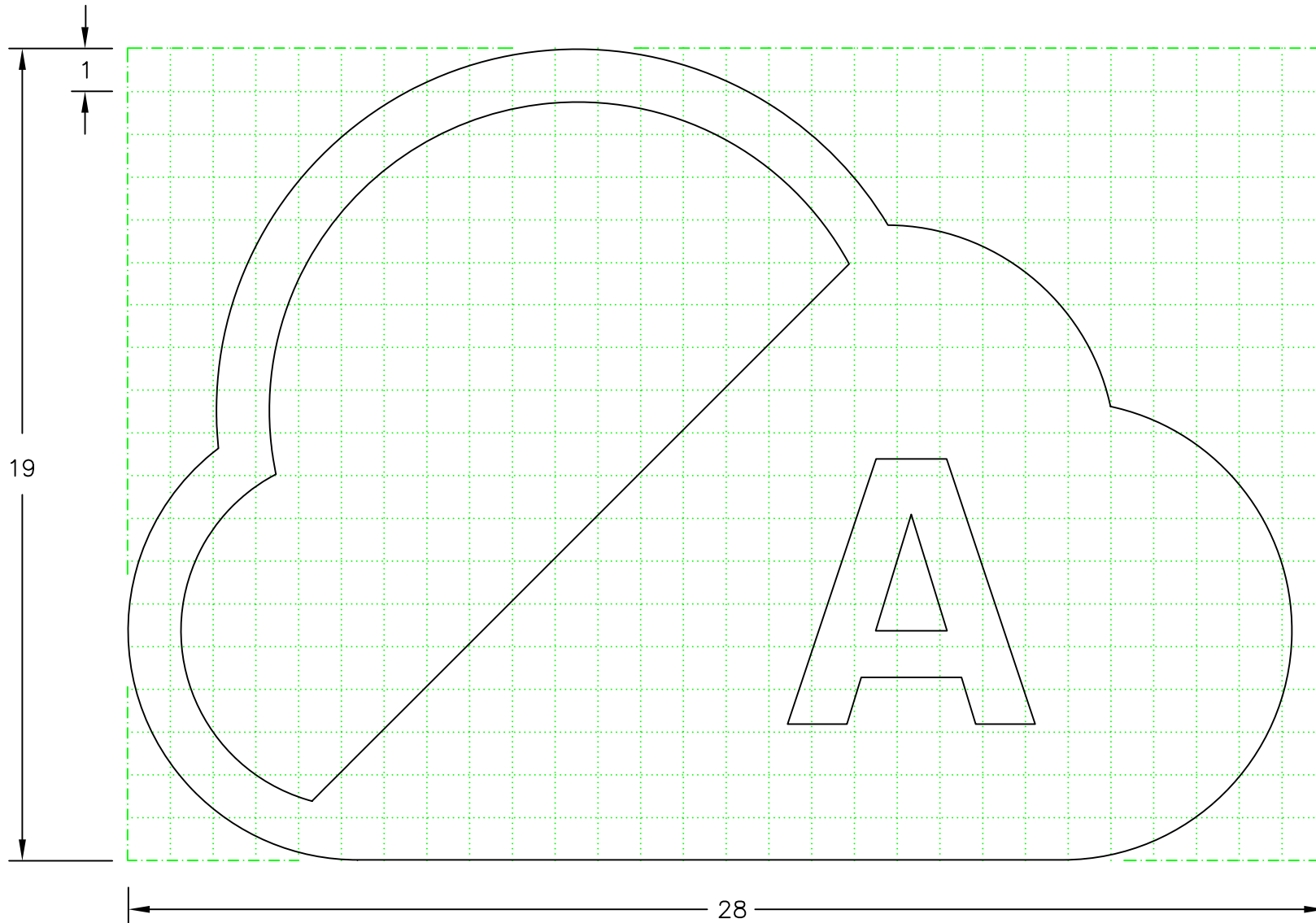

NOTES:

1. The grid does not form part of any sign to which the symbol is applied.
2. Dimensions are given in grid divisions.
3. The symbol is not reversible.
4. The legend is from the Transport Heavy alphabet.

S68

© CROWN COPYRIGHT



Title : Symbol  
**CLEAN AIR ZONE**

Issue: Date :  
 A : 31.8.18  
 B :  
 C :

Drawn by :  
 A.K.  
 Approved by:  
 J.B.

Related drawings :

Drawing No.  
**S 68** sheet  
 2 of 5



Before using this drawing, confirm that it has not been superseded.

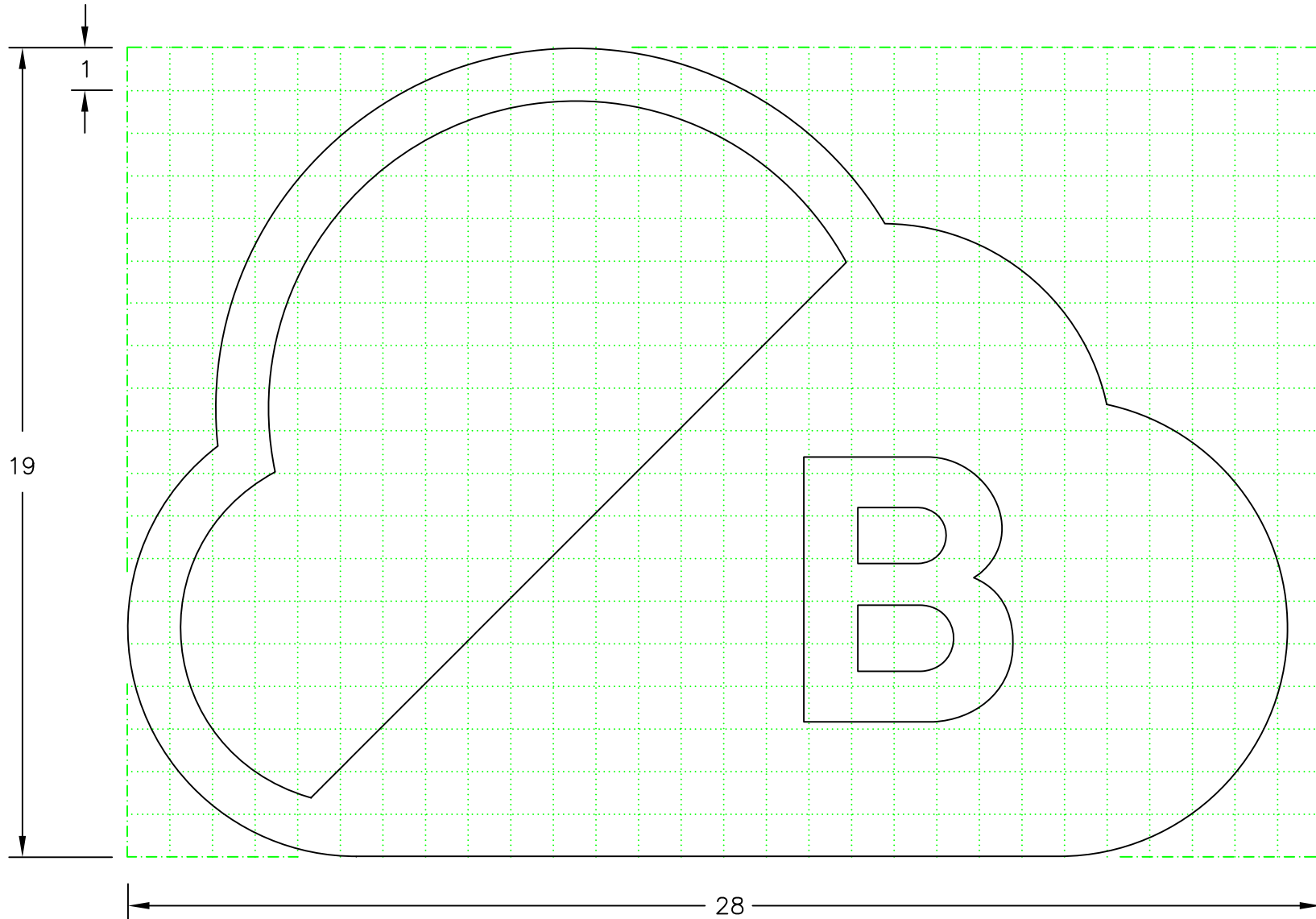

NOTES:

1. The grid does not form part of any sign to which the symbol is applied.
2. Dimensions are given in grid divisions.
3. The symbol is not reversible.
4. The legend is from the Transport Heavy alphabet.

S68

© CROWN COPYRIGHT

 Department for Transport	Title :  Symbol  <b>CLEAN AIR ZONE</b>	Issue : A : B : C :	Date : 31.8.18	Drawn by : A.K. Approved by : J.B.	Related drawings :  Drawing No.  <b>S 68</b> sheet 3 of 5
---	--	------------------------------	-------------------	---	--

Before using this drawing, confirm that it has not been superseded.

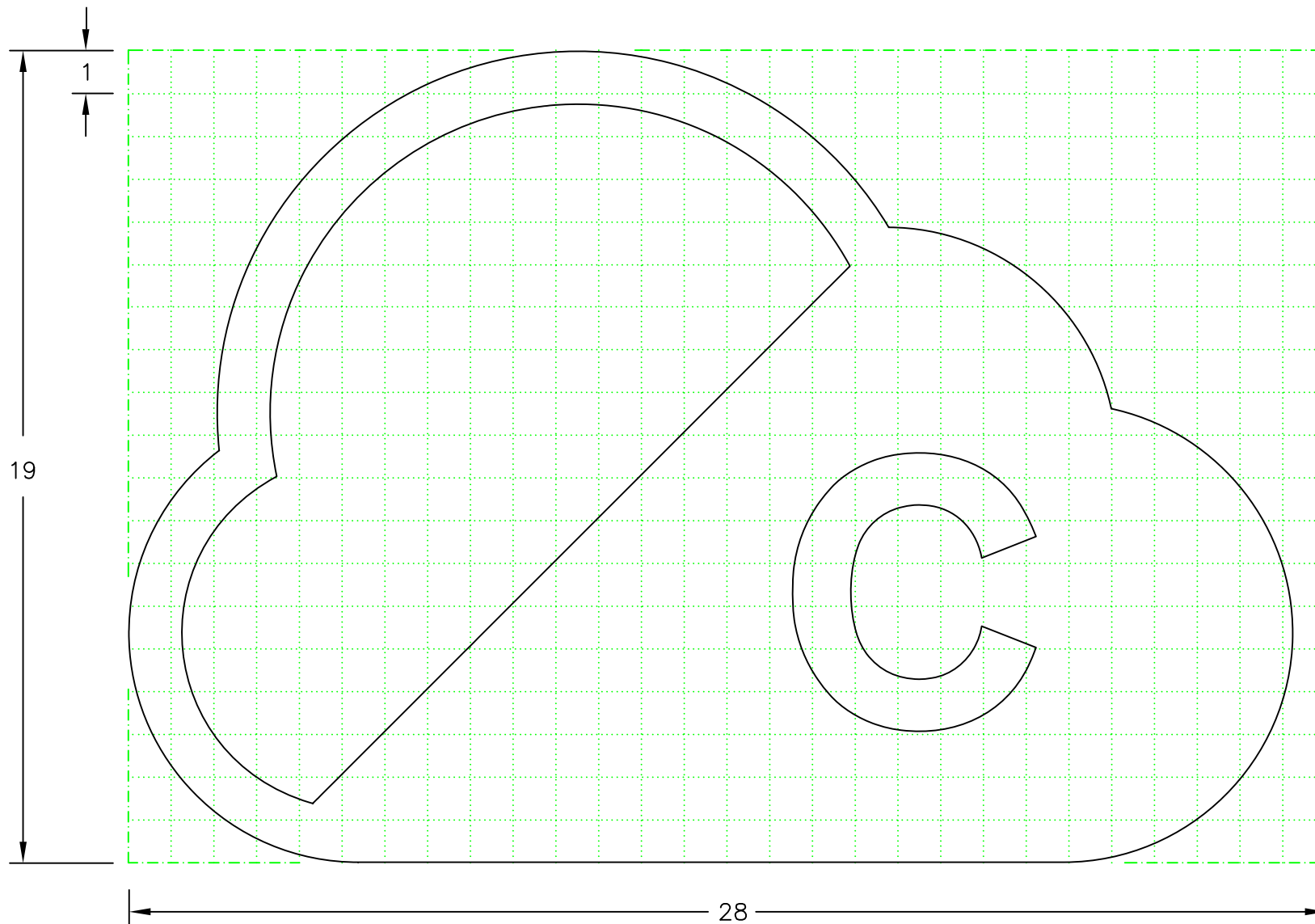

NOTES:

1. The grid does not form part of any sign to which the symbol is applied.
2. Dimensions are given in grid divisions.
3. The symbol is not reversible.
4. The legend is from the Transport Heavy alphabet.

S68

© CROWN COPYRIGHT



Title:

CLEAN AIR ZONE

Symbol

Issue: Date:

A: 31.8.18

B:

C:

Drawn by:

A.K.

Approved by:

J.B.

Related drawings:

Drawing No.

S 68 sheet 4 of 5

Before using this drawing, confirm that it has not been superseded.

NOTES:

1. The grid does not form part of any sign to which the symbol is applied.
2. Dimensions are given in grid divisions.
3. The symbol is not reversible.
4. The legend is from the Transport Heavy alphabet.

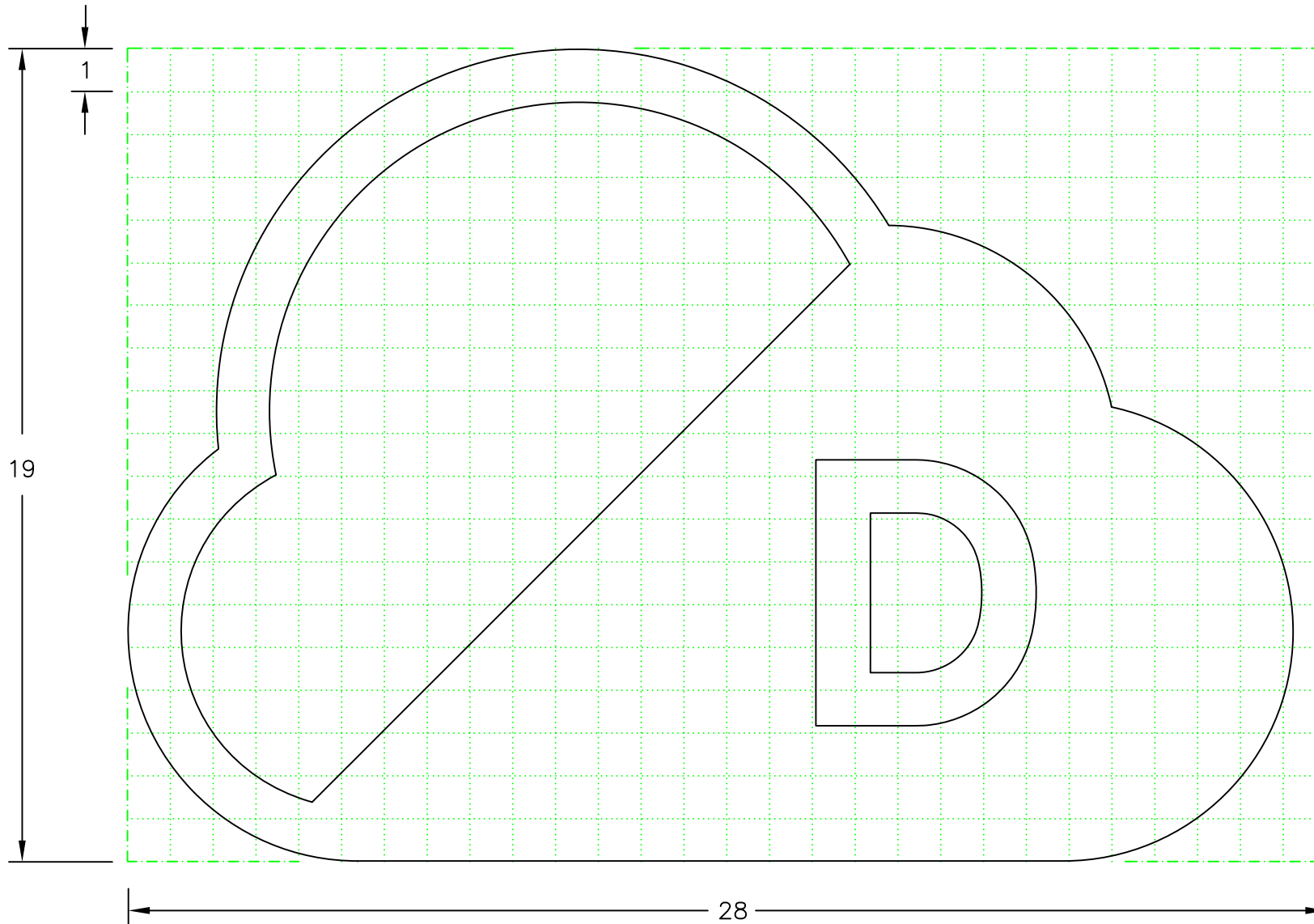

S68

© CROWN COPYRIGHT



Title:

Symbol

CLEAN AIR ZONE

Issue: Date:

A: 31.8.18

B:

C:

Drawn by:

A.K.

Approved by:

J.B.

Related drawings:

Drawing No.

S 68 sheet 5 of 5





**KEEKALD  
CLEAN AIR ZONE  
BOUNDARY**

**WILL OPERATE  
AT ALL TIMES  
FROM  
21 JULY 2020**

**CHARGES APPLY  
CHECK ONLINE**

**Sign E**